



600W Single Output with PFC Function

HRP-600N series



■ Features

- Universal AC input / Full range
- Built-in active PFC function, PF>0.94
- 250% peak power capability
- High efficiency up to 89%
- Withstand 300VAC surge input for 5 seconds
- Protections: Short circuit / Overload / Over voltage / Over temperature
- Built-in cooling fan ON-OFF control
- Built-in DC OK signal
- Built-in remote sense function
- 5 years warranty

■ Applications

- Industrial automation machinery
- Industrial control system
- Mechanical and electrical equipment
- Diagnostic or biological facilities
- Test or measurement systems
- Telecommunication equipment

■ Description

HRP-600N is a 600W single output type AC/DC power supply. This series operates for 85~264VAC input voltage and offers the models with the DC output mostly demanded from the industry. Each model is cooled by the built-in fan with fan ON-OFF control, working for the temperature up to 70°C. Moreover, HRP-600N provides 250% short-duration peak power for motor applications and electromechanical loads requiring much higher power during start-up.

■ Model Encoding

HRP - 600N - 24

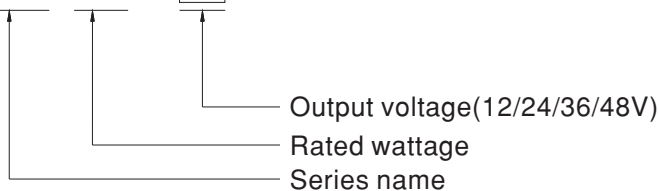



SPECIFICATION

| MODEL | | HRP-600N-12 | HRP-600N-24 | HRP-600N-36 | HRP-600N-48 | |
|--------------------------------|---|---|--|----------------|--|--|
| OUTPUT | DC VOLTAGE | 12V | 24V | 36V | 48V | |
| | RATED CURRENT | 53A | 27A | 17.5A | 13A | |
| | CURRENT RANGE | 0 ~ 53A | 0 ~ 27A | 0 ~ 17.5A | 0 ~ 13A | |
| | RATED POWER | 636W | 648W | 630W | 624W | |
| | RIPPLE & NOISE (max.) Note.2 | 200mVp-p | 150mVp-p | 200mVp-p | 240mVp-p | |
| | VOLTAGE ADJ. RANGE | 10.2 ~ 13.8V | 21.6 ~ 28.8V | 28.8 ~ 39.6V | 40.8 ~ 55.2V | |
| | VOLTAGE TOLERANCE Note.3 | ± 1.0% | ± 1.0% | ± 1.0% | ± 1.0% | |
| | LINE REGULATION | ± 0.3% | ± 0.2% | ± 0.2% | ± 0.2% | |
| | LOAD REGULATION | ± 0.5% | ± 0.5% | ± 0.5% | ± 0.5% | |
| | SETUP, RISE TIME | 1800ms, 50ms/230VAC 3600ms, 50ms/115VAC at full load | | | | |
| HOLD UP TIME (Typ.) | 16ms/230VAC 16ms/115VAC at full load | | | | | |
| INPUT | VOLTAGE RANGE Note.4 | 85 ~ 264VAC 120 ~ 370VDC | | | | |
| | FREQUENCY RANGE | 47 ~ 63Hz | | | | |
| | POWER FACTOR (Typ.) | PF>0.94/230VAC PF>0.98/115VAC at full load | | | | |
| | EFFICIENCY (Typ.) | 88% | 88% | 89% | 89% | |
| | AC CURRENT (Typ.) | 7.6A/115VAC 3.6A/230VAC | | | | |
| | INRUSH CURRENT (Typ.) | 35A/115VAC 70A/230VAC | | | | |
| LEAKAGE CURRENT | <1.5mA / 240VAC | | | | | |
| PROTECTION | OVERLOAD | Normally works within 105 ~ 200% rated output power for more than 5 seconds and then shut down o/p voltage, re-power on to recover Constant current limiting for output power >280% rated for more than 5 seconds and then shut down o/p voltage, re-power on to recover | | | | |
| | OVER VOLTAGE | 14.4 ~ 16.8V | 30 ~ 34.8V | 41.4 ~ 48.6V | 57.6 ~ 67.2V | |
| | OVER TEMPERATURE | Shut down o/p voltage, recovers automatically after temperature goes down Protection type : Shut down o/p voltage, re-power on to recover | | | | |
| FUNCTION | DC OK SIGNAL | PSU turn on : 3.3 ~ 5.6V ; PSU turn off : 0 ~ 1V | | | | |
| | FAN CONTROL (Typ.) | Load 35 ± 15% or RTH2 ≥ 50°C Fan on | | | | |
| ENVIRONMENT | WORKING TEMP. | -40 ~ +70°C (Refer to "Derating Curve") | | | | |
| | WORKING HUMIDITY | 20 ~ 90% RH non-condensing | | | | |
| | STORAGE TEMP., HUMIDITY | -40 ~ +85°C, 10 ~ 95% RH non-condensing | | | | |
| | TEMP. COEFFICIENT | ± 0.03%/°C (0 ~ 50°C) | | | | |
| | VIBRATION | 10 ~ 500Hz, 5G 10min./1cycle, 60min. each along X, Y, Z axes | | | | |
| | OPERATING ALTITUDE Note.6 | 5000 meters | | | | |
| SAFETY & EMC (Note 5) | SAFETY STANDARDS | UL62368-1, TUV BS EN/EN62368-1, EAC TP TC 004, AS/NZS 62368.1 approved | | | | |
| | WITHSTAND VOLTAGE | I/P-O/P:3KVAC I/P-FG:2KVAC O/P-FG:0.5KVAC | | | | |
| | ISOLATION RESISTANCE | I/P-O/P, I/P-FG, O/P-FG:100M Ohms / 500VDC / 25°C / 70% RH | | | | |
| | EMC EMISSION | Parameter | Standard | | Test Level / Note | |
| | | Conducted | BS EN/EN55032 | | Class B | |
| | | Radiated | BS EN/EN55032 | | Class B | |
| | | Harmonic current | BS EN/EN61000-3-2 | | Class A | |
| | | Voltage Flicker | BS EN/EN61000-3-3 | | ----- | |
| | EMC IMMUNITY | BS EN/EN55035 , BS EN/EN61000-6-2(BS EN/EN50082-2) | | | | |
| | | Parameter | Standard | | Test Level / Note | |
| | | ESD | BS EN/EN61000-4-2 | | Level 3, 8KV air; Level 2, 4KV contact | |
| | | RF field | BS EN/EN61000-4-3 | | Level 3, 10V/m | |
| | | EFT/ Burst | BS EN/EN61000-4-4 | | Level 3, 2KV | |
| | | Surge | BS EN/EN61000-4-5 | | Level 4, 4KV/Line-FG; 2KV/Line-Line | |
| Conducted | | BS EN/EN61000-4-6 | | Level 3, 10V | | |
| Magnetic Field | | BS EN/EN61000-4-8 | | Level 4, 30A/m | | |
| Voltage Dips and Interruptions | BS EN/EN61000-4-11 | | 95% dip 0.5 periods, 30% dip 25 periods, 95% interruptions 250 periods | | | |
| OTHERS | MTBF | 452.04K hrs min. Telcordia TR/SR-332 (Bellcore) ; 191.26K hrs min. MIL-HDBK-217F (25°C) | | | | |
| | DIMENSION | 218*105*61.5mm (L*W*H) | | | | |
| | PACKING | 1.39Kg;8pcs/12.1Kg/1.58CUFT | | | | |
| NOTE | <p>1. All parameters NOT specially mentioned are measured at 230VAC input, rated load and 25°C of ambient temperature. 2. Ripple & noise are measured at 20MHz of bandwidth by using a 12" twisted pair-wire terminated with a 0.1uf & 47uf parallel capacitor. 3. Tolerance : includes set up tolerance, line regulation and load regulation. 4. Derating may be needed under low input voltages. Please check the derating curve for more details. 5. The power supply is considered a component which will be installed into a final equipment. All the EMC tests are been executed by mounting the unit on a 360mm*360mm metal plate with 1mm of thickness. The final equipment must be re-confirmed that it still meets EMC directives. For guidance on how to perform these EMC tests, please refer to "EMI testing of component power supplies." (as available on http://www.meanwell.com) 6. The ambient temperature derating of 3.5°C/1000m with fanless models and of 5°C/1000m with fan models for operating altitude higher than 2000m(6500ft). ※ Product Liability Disclaimer : For detailed information, please refer to https://www.meanwell.com/serviceDisclaimer.aspx</p> | | | | | |

Block Diagram

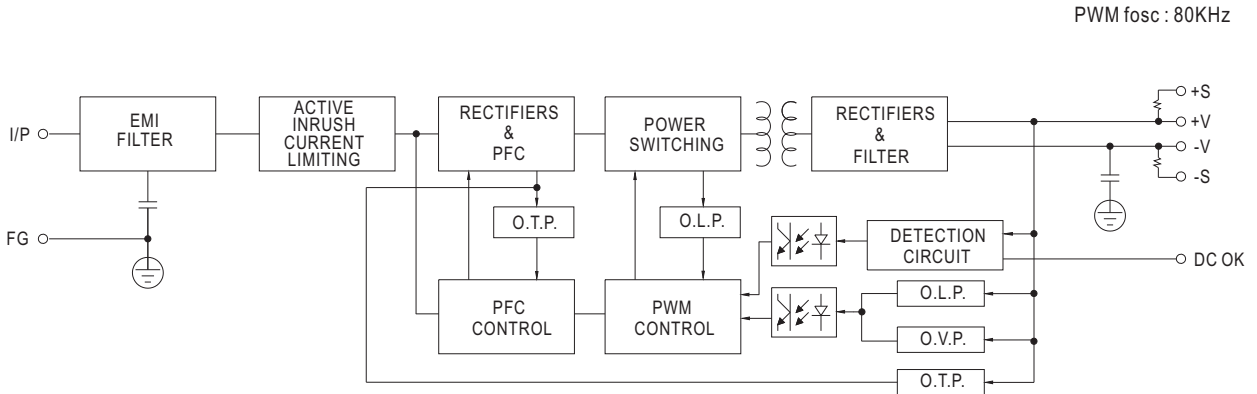

Derating Curve

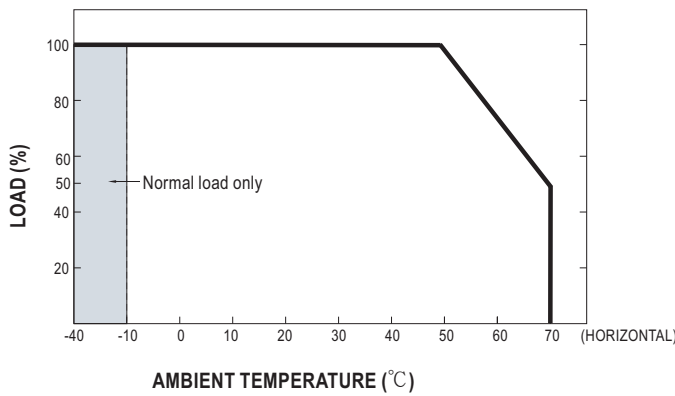

Output Derating VS Input Voltage

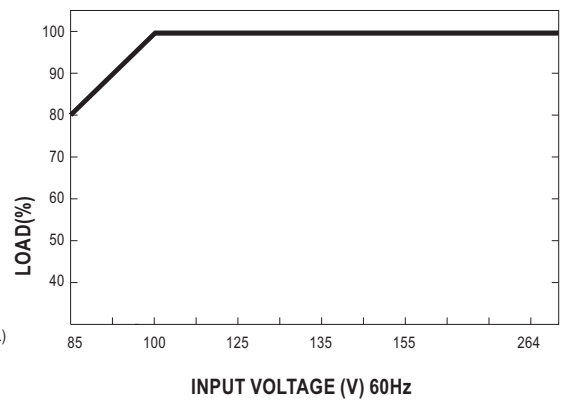

Function Manual

1. Remote Sense

The remote sensing compensates voltage drop on the load wiring up to 0.5V.

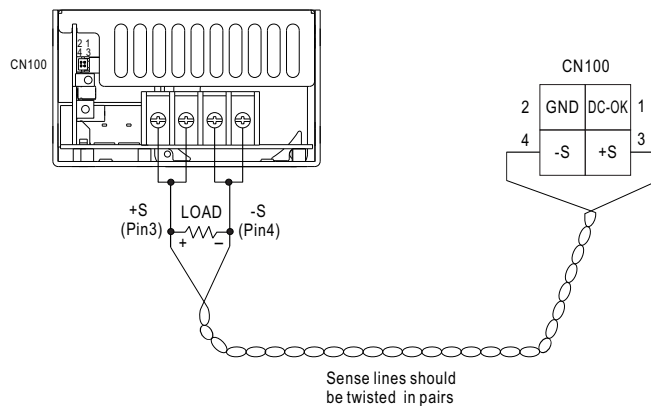

Fig 1.1

2. DC-OK Signal

DC-OK signal is a TTL level signal. High when PSU turns on.

| Between DC-OK(pin1) and GND(pin2) | Output Status |
|-----------------------------------|---------------|
| 3.3 ~ 5.6V | ON |
| 0 ~ 1V | OFF |

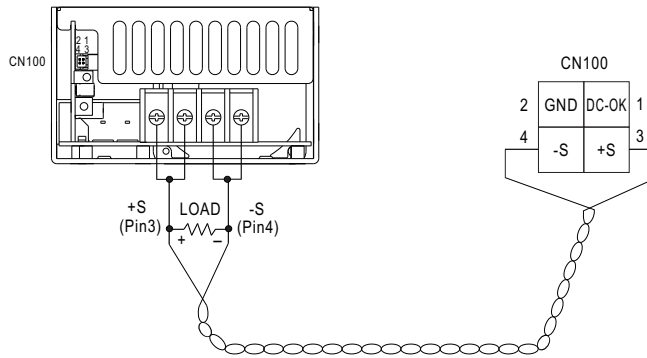

Fig 2.1

Sense lines should be twisted in pairs

3. Peak Power

$$P_{av} = \frac{P_{pk} \times t + P_{npk} \times (T-t)}{T} \leq P_{rated}$$

$$\text{Duty} \frac{t}{T} \times 100\% \leq 35\%$$

$$t \leq 5 \text{ sec}$$

P_{av} : Average output power (W)

P_{pk} : Peak output power (W)

P_{npk} : Non-peak output power (W)

P_{rated} : Rated output power (W)

t : Peak power width (sec)

T : Period (sec)

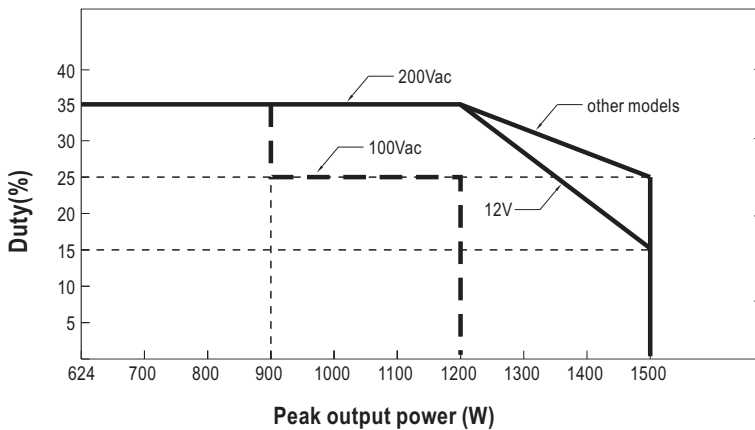
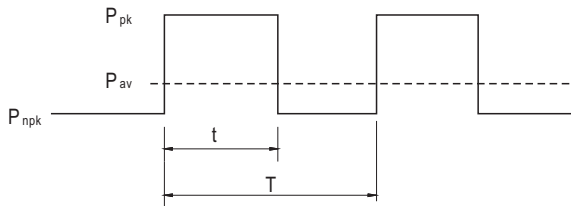

For example (12V model) :

$V_{in} = 100V$ $\text{Duty}_{max} = 25\%$

$P_{av} = P_{rated} = 636W$

$P_{pk} = 1200W$

$t \leq 5 \text{ sec}$

$T \geq 20 \text{ sec}$

$$P_{av} = \frac{P_{pk} \times t + P_{npk} \times (T-t)}{T} = \frac{1200 \times 5 + P_{npk} \times (20-5)}{20} \leq 636W$$

$P_{npk} \leq 448W$

Mechanical Specification

Case No. 977A Unit:mm

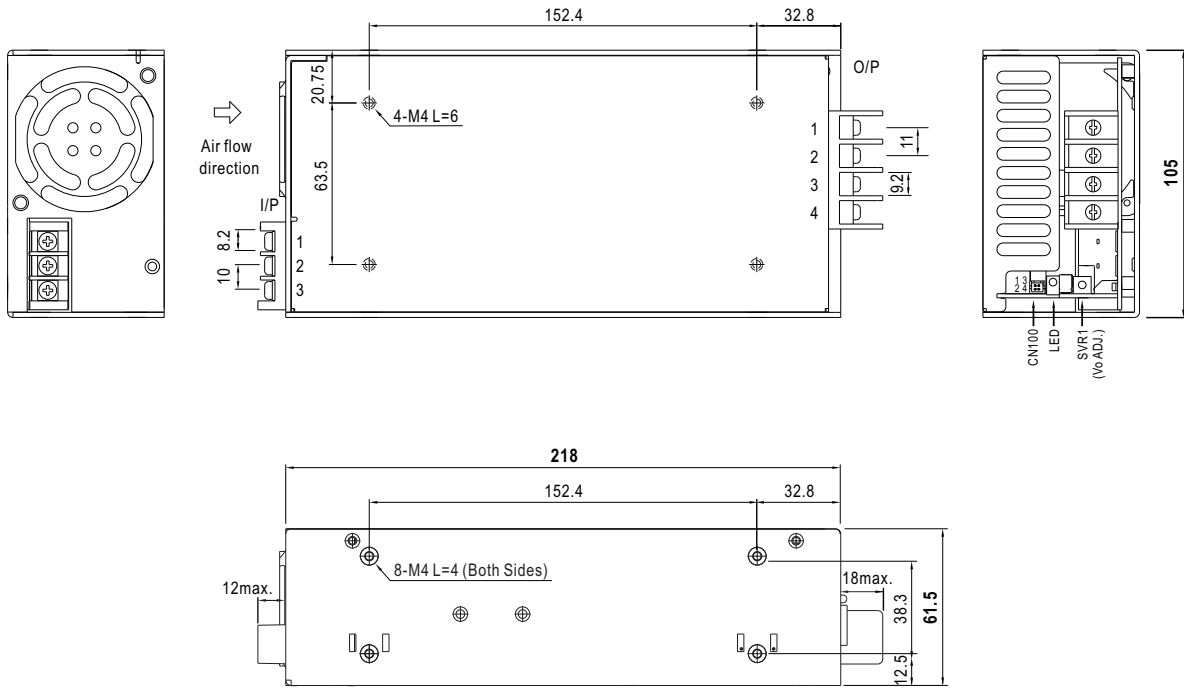

AC Input Terminal Pin No. Assignment

| Pin No. | Assignment |
|---------|------------|
| 1 | AC/L |
| 2 | AC/N |
| 3 | FG \perp |

DC Output Terminal Pin No. Assignment

| Pin No. | Assignment |
|---------|------------|
| 1~2 | -V |
| 3~4 | +V |

Connector Pin No. Assignment(CN100) : HRS DF11-4DP-2DS or equivalent

| Pin No. | Assignment | Mating Housing | Terminal |
|---------|------------|----------------------------|----------------------------|
| 1 | DC-OK | HRS DF11-4DS or equivalent | HRS DF11-4SC or equivalent |
| 2 | GND | | |
| 3 | +S | | |
| 4 | -S | | |

Installation Manual

Please refer to : <http://www.meanwell.com/manual.html>